

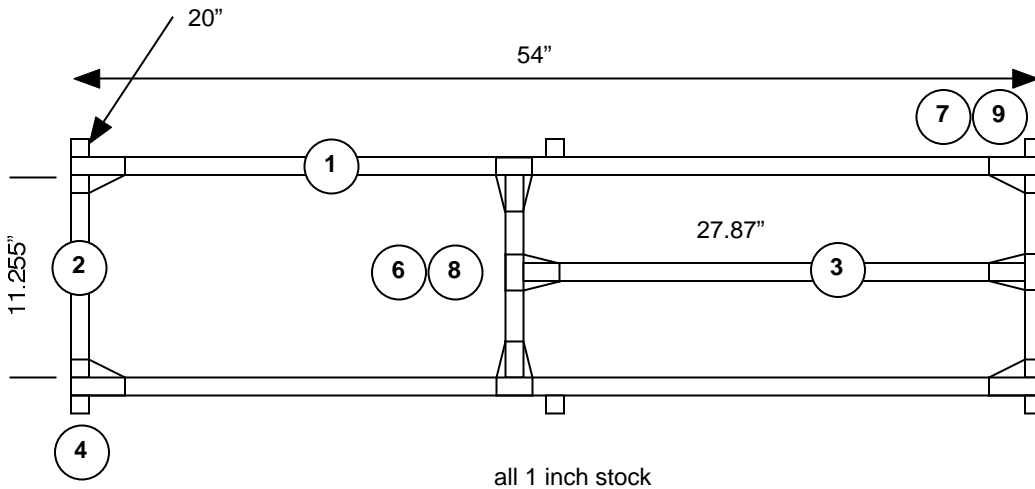

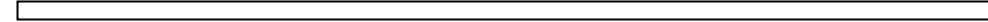



4 Scintillator frames per site

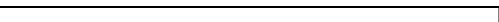
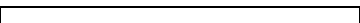

all 1 inch stock



- 1 8 @ 54"  
1010
- 2 12 @ 11.255"  
1010 
- 3 4 @ 27.8275"  
1010 
- 4 12 @ 20"  
1010 
- 5 24 @ 4176 10 Series 3 hole  
inside corner bracket 
- 6 16 @ 4141 10 Series 4 hole  
Tee Joining Plate 
- 7 16 @ 4151 10 Series 4 hole  
90° Joining Plate 
- 8 44 @ 3356 double economy T-nut w/2  
1/4-20 X 1/2"FBHSCS
- 9 12 @ 3393 1/4-20 X 1/2" BHSCS &  
economy T-Nut